

# GROUND RESISTANCE TESTERS

## MULTI-FUNCTION

### MODEL 6471

Test ground resistance without the need of auxiliary rods or with the 3- and 4- Point methods



DataView®



cover closed



### SPECIFICATIONS

MODEL	6471
<b>ELECTRICAL</b>	
<b>2-Clamp Measurement</b>	
Range	(0.10 to 500) Ω
Resolution	(0.01 to 1) Ω
Measurement Frequency	Auto: 1611 Hz Manual: (128, 1367, 1611, or 1758) Hz
<b>3-Point Measurement</b>	
Range (Auto-Ranging)	0.09 Ω to 99.9 kΩ
Resolution	(0.01 to 100) Ω
Test Voltage	Nominal (16 or 32) Vrms user selectable
Resistance Measurement Frequency	(41 to 513) Hz automatic or user selectable
Test Current	Up to 250 mA
Accuracy	± 2 % of Reading + 1 ct @ 128 Hz
<b>Soil Resistivity 4-Point Measurement</b>	
Test Method	Wenner or Schlumberger selectable with automatic calculation in Ω-meters
Range (Auto-Ranging)	(0.01 to 99.9) kΩ; ρ max: 999 kΩm
Resolution	(0.01 to 100) Ω
Test Voltage	(16 or 32) V user selectable
Frequency	From (41 to 128) Hz selectable
<b>External Voltage Measurement</b>	
Range (Auto-Ranging)	(0.1 to 65.0) V <sub>AC/DC</sub> – DC to 440 Hz
Accuracy	± 2 % of Reading + 1 ct
<b>Resistance Measurement (Bond Testing)</b>	
Measurement Type	2-Pole (with lead resistance compensation) or 4-Pole (Kelvin sensing) user selectable
Range (Auto-Ranging)	2-Pole (0.12 to 99.99) kΩ; 4-Pole (0.02 to 99.99) kΩ
Accuracy	± 2 % of Reading + 2 cts
Test Voltage	16 V <sub>DC</sub> (+, - or auto polarity)
Test Current	Up to 250 mA max
<b>Data Storage</b>	
Memory Capacity	512 test results (64 kB)
Communication	Optically Isolated USB
Power Supply	9.6 V rechargeable battery pack (included)
Recharging Source	110 V/220 V, (50/60) Hz external charger with 18 V <sub>DC</sub> , 1.9 A output



#### GROUND RESISTANCE MEASUREMENT USING 2 PROBES

For systems with parallel ground connections, Models 6471 and 6472 are capable of accurately measuring a ground resistance using probes only. This method involves placing 2 probes around the ground conductor to be tested and connecting them each to the instrument. One probe injects a known signal (32 V/1367 Hz) while the other probe measures the current circulating in the loop. This method saves considerable time when ground testing because it is no longer necessary to set up auxiliary rods or to disconnect the ground connector.

### PRODUCT INCLUDES

#### CAT. #2135.48 MODEL 6471 (without probes)

Meter, carrying bag, 110 V/240 V power adapter with US power cord, optical USB cable, rechargeable NiMH battery, and a USB drive with DataView® software, ground tester workbook and user manual.

#### CAT. #2135.49 MODEL 6471 (with probes)

Meter, carrying bag, set of (2) SR182 current probes, 110 V/240 V power adapter with US power cord, optical USB cable, rechargeable NiMH battery, and a USB drive with DataView® software, ground tester workbook and user manual.

#### KIT SHOWN 300 FT KIT: CATALOG #2135.50

Meter, carrying bag for kit, (2) 300 ft color-coded (red/blue) leads on spools, (2) 5 ft color-coded (red/blue) leads, (2) 100 ft hand-tied color-coded (green/black) leads, set of (2) SR182 current probes, 110 V/240 V power adapter with US power cord, optical USB cable, (4) T-shaped auxiliary ground electrodes, set of (5) spaded lugs, 100 ft tape measure, rechargeable NiMH battery, and a USB drive with DataView® software, ground tester workbook and user manual.

2 probes required to perform stakeless testing

Consult factory for NIST Calibration prices

### ACCESSORIES



**MN82 CURRENT PROBE**  
(2 mA to 10 Arms)  
Catalog #2135.71



**SR182 CURRENT PROBE**  
(0.5 mA to 40 Arms)  
Catalog #2135.72



**REEL CADDY**  
Catalog #2135.85 Set of (2),  
for use with ground kit spools



# GROUND RESISTANCE TESTERS

## MULTI-FUNCTION

### MODEL 6472

Use under difficult conditions such as the presence of high stray currents that normally affect accuracy



DataView®



### SPECIFICATIONS

MODEL	6472
<b>ELECTRICAL</b>	
<b>2-Clamp Measurement</b>	
Range	(0.1 to 500) Ω
Resolution	(0.01 to 1) Ω
Measurement Frequency	Auto: 1611 Hz Manual: (128, 1367, 1611, or 1758) Hz
<b>3-Point Measurement</b>	
Range (Auto-Ranging)	0.09 Ω to 99.9 kΩ
Resolution	(0.01 to 100) Ω
Test Voltage	Nominal (10, 16, 32 or 60) Vrms user selectable
Resistance Measurement Frequency	(41 to 5078) Hz automatic or user selectable
Test Current	Up to 250 mA
Accuracy	± 2 % of Reading + 1 ct @ 128 Hz
<b>Soil Resistivity 4-Point Measurement</b>	
Test Method	Wenner or Schlumberger selectable with automatic calculation of test results in Ω-meters
Range (Auto-Ranging)	(0.01 to 99.9) kΩ; ρ max: 999 kΩm
Resolution	(0.01 to 100) Ω
Test Voltage	(10, 16, 32 or 60) V user selectable
Frequency	From (41 to 128) Hz selectable
<b>External Voltage Measurement</b>	
Range (Auto-Ranging)	(0.1 to 65.0) VAC/DC – DC to 440 Hz
Accuracy	± 2 % of Reading + 1 ct
<b>Resistance Measurement (Bond Testing)</b>	
Measurement Type	2-Pole (with lead resistance compensation) or 4-Pole (Kelvin sensing) user selectable
Range (Auto-Ranging)	2-Pole 0.12 Ω to 99.99 kΩ; 4-Pole 0.02 Ω to 99.99 kΩ
Accuracy	± 2 % of Reading + 2 cts
Test Voltage	16 Vdc (+, - or auto polarity)
Test Current	Up to 250 mA max
<b>Data Storage</b>	
Memory Capacity	512 test results (64 kB)
Communication	Optically Isolated USB
Power Supply	9.6 V rechargeable battery pack (included)
Recharging Source	110 V/220 V, (50/60) Hz external charger with 18 Vdc, 1.9 A output

Consult factory for NIST Calibration prices

### ACCESSORIES

**MN82 CURRENT PROBE**  
(2 mA to 10 Arms)  
Catalog #2135.71



**SR182 CURRENT PROBE**  
(0.5 mA to 40 Arms)  
Catalog #2135.72



**REEL CADDY**  
Catalog #2135.85  
Set of (2), for use with ground kit spools



The Model 6472 provides an automated way to measure the value of the earth/ground using the Fall-of-Potential method and storing measurements.

### PRODUCT INCLUDES

Carrying bag, (110/240) V power adapter with US power cord, optical USB cable, rechargeable NiMH battery, and a USB drive with DataView® software, ground tester workbook and user manual.

### TEST KITS

**6472 METER**  
300 ft Kit: Catalog #2135.53  
500 ft Kit: Catalog #2135.54 (shown)

Refer to page 75 for Model 6472 Kit descriptions Catalog #2135.35, #2135.36 and #2135.37



*2 probes required to perform stakeless testing*

# GROUND RESISTANCE TESTERS

## MULTI-FUNCTION

### LARGE FUNCTIONAL DISPLAYS

### FEATURES

- Ground Resistance testing using the 2-clamp method (no auxiliary rods needed)
- 2- and 4-Point Resistance/Continuity measurement (DC Resistance) with automatic polarity reversal
- 3-Point Fall-of-Potential measurement with manual or automatic frequency selection
- 4-Point Soil Resistivity measurement with automatic calculation of Rho ( $\rho$ ) and user selection of the Wenner or Schlumberger test method
- 3-Point Earth Coupling measurement
- Manual and Automatic frequency scan from (41 to 5078) Hz for optimum test accuracy in electrically noisy environments
- Selectable test voltage of (10, 16, 32 or 60) V up to 250 mA of test current (model dependant)
- Auto Power OFF feature
- Automatic recognition of all electrode connections and their resistance value
- Stores up to 512 complete test results in internal memory
- Display with automatic backlight when entering a function
- Optically isolated USB communication cable included
- Rechargeable NiMH batteries from wall charger or vehicle power (Cat. #2135.43 needed for vehicle power)
- Rugged dustproof and water-resistant field case (IP53 rated in closed position)
- Grounding standards IEC 61557 parts 4 and 5 compliant
- Includes DataView® software for set up, data retrieval, real-time display, analysis, report generation and system configuration
- Can also be used for continuity tests on bonding

#### 4-POINT-TO-POINT

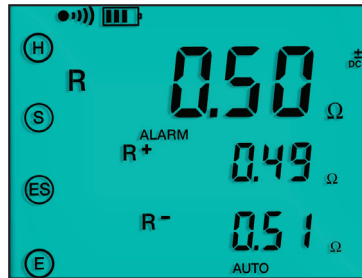

The 4-Point test shows lead connections, Continuity test results, test voltage and current

#### 3-POINT FALL-OF-POTENTIAL TEST

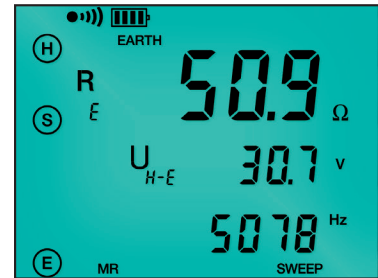

The 3-Point Fall-of-Potential test displays test lead connection, grounding rod resistance and test electrode resistances

#### SCHLUMBERGER TEST

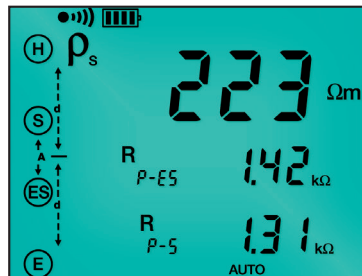

The Schlumberger test displays test lead connection, soil resistivity ( $\rho$ ) test results and electrode spacing

#### TWO CLAMP TEST

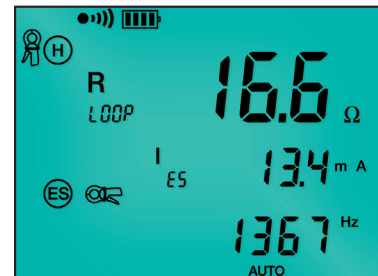

The 2-Clamp method displays clamp connection resistance, test current and frequency

#### DATA STORAGE



Memory Recall displays test results stored at a specific memory location

#### WENNER TEST

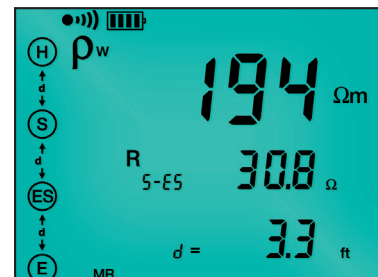

The Wenner test displays test lead connection, soil resistivity ( $\rho$ ) test results, electrode spacing and resistance

2 probes required to perform stakeless testing.

CATALOG NO.	DESCRIPTION
2135.48	Ground Resistance Tester Model 6471 (Digital, 3-Point, 4-Point, Clamp-on (SR182 probes not included), DataView® Software)
2135.49	Ground Resistance Tester Model 6471 (Digital, 3-Point, 4-Point, Clamp-on, (includes 2-SR182 probes), DataView® Software)
2135.50	Ground Resistance Tester Model 6471 Kit – 300 ft (Catalog #2135.49 and Catalog #2135.36)
2135.51	Ground Resistance Tester Model 6472 (Digital, 2-Point, 3-Point, 4-Point, Bond Test, DataView® software)
2135.53	Ground Resistance Tester Model 6472 Kit – 300 ft (Catalog #2135.51 and Catalog #2135.36)
2135.54	Ground Resistance Tester Model 6472 Kit – 500 ft (Catalog #2135.51 and Catalog #2135.37)
2135.60	Ground Resistance Tester Model 6471 Kit – 300 ft w/o Probes (Catalog #2135.48 and Catalog #2135.36)
2135.61	Ground Resistance Tester Model 6471 Kit – 500 ft w/o Probes (Catalog #2135.48 and Catalog #2135.37)

# GROUND RESISTANCE TESTERS

## MULTI-FUNCTION

### GROUND TESTERS MODELS 6471 & 6472 — TYPICAL DATAVIEW® FUNCTIONAL DISPLAYS

2-CLAMP METHOD SETUP

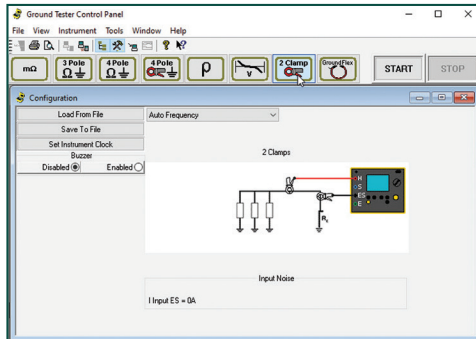

FALL-OF-POTENTIAL, STEP-TOUCH POTENTIAL

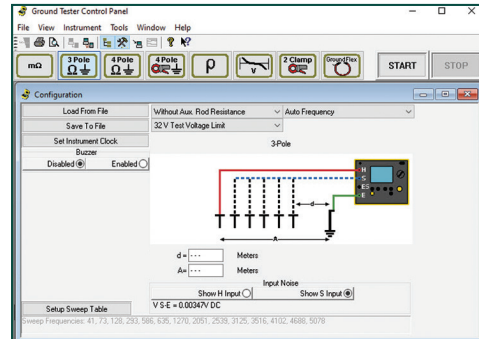

SELECTIVE 3-POINT TESTING OF MULTIPLE RODS

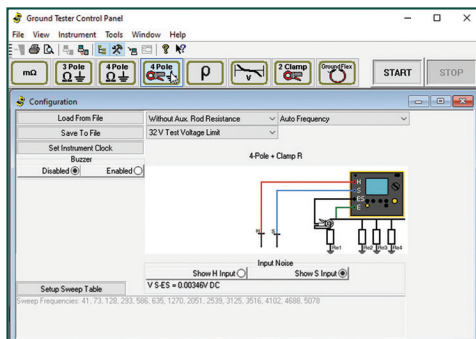

4-POINT-TO-POINT

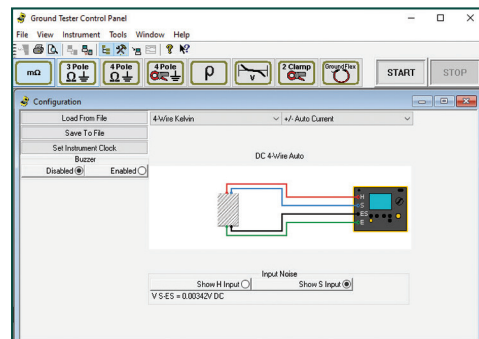

2-POINT-TO-POINT

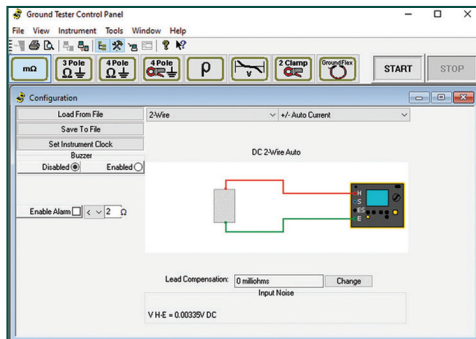

SOIL RESISTIVITY

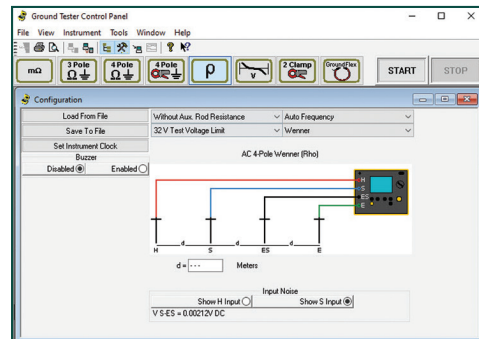

## OPTIONAL KITS

### 150 FT KIT

Catalog #2135.35

Test Kit for 3-Point testing includes carrying bag, (2) 150 ft color-coded (red/blue) leads on spools, (2) 5 ft color-coded (red/blue) leads, (1) 30 ft lead (green), (2) 14.5 in T-shaped auxiliary ground electrodes, a set of (5) spaded lugs and (1) 100 ft tape measure.



### 300 FT KIT

Catalog 2135.36

Test Kit for 4-Point testing includes carrying bag, (2) 300 ft color-coded (red/blue) leads on spools, (2) 5 ft color-coded (red/blue) leads, (2) 100 ft hand-tied color-coded leads (green/black), (4) 14.5 in T-shaped auxiliary ground electrodes, a set of (5) spaded lugs and (1) 100 ft tape measure.



### 500 FT KIT

Catalog #2135.37

Test Kit for 4-Point testing includes carrying bag, (2) 500 ft color-coded (red/blue) leads on spools, (2) 5 ft color-coded (red/blue) leads, (2) 100 ft hand-tied color-coded (green/black) leads, (1) 30 ft lead (green), (4) 14.5 in T-shaped auxiliary ground electrodes, a set of (5) spaded lugs and (1) 100 ft tape measure.



# GROUND RESISTANCE TESTERS

## SELECTION CHART

AEMC MODEL NUMBER	AEMC CATALOG NUMBER	RESISTANCE RANGE	POWER SOURCE	2 POINT TEST	3 POINT TEST	4 POINT/ SELECTIVE	SOIL RESISTIVITY TEST	EARTH COUPLING	2 CLAMP	DISPLAY	ADJUSTABLE FREQUENCY	SWEEP FREQUENCY
6422	2135.55	0.05 Ω to 2 kΩ	Battery	✓		- / -		-		Digital	Auto (128 or 256) Hz	-
6422 Kit 150 FT	2135.56	0.05 Ω to 2 kΩ	Battery	✓		- / -		-		Digital	Auto (128 or 256) Hz	-
6424	2135.57	0.05 Ω to 50 kΩ	Rechargeable Battery	✓		- / -		-		Digital	Auto (128 or 256) Hz	-
6424 Kit 150 FT	2135.58	0.05 Ω to 50 kΩ	Rechargeable Battery	✓		- / -		-		Digital	Auto (128 or 256) Hz	-
6424 Kit 300 FT	2135.59	0.05 Ω to 50 kΩ	Rechargeable Battery	✓		- / -		-		Digital	Auto (128 or 256) Hz	-
GroundFlex® Field Kit Model 6474	2136.03	0.001 Ω to 99.99 kΩ	Rechargeable Battery	-	✓	✓ / -	✓		-	Digital	Auto (41 to 5078) Hz	✓
6471 (SR182 probes not included)	2135.48	0.001 Ω to 99.99 kΩ	Rechargeable Battery	✓		✓ / ✓	✓		✓***	Digital	Auto (41 to 513) Hz	✓
6471	2135.49	0.001 Ω to 99.99 kΩ	Rechargeable Battery	✓		✓ / ✓	✓			Digital	-	✓
6471 Kit 300 FT (with probes)	2135.50	0.001 Ω to 99.99 kΩ	Rechargeable Battery	✓		✓ / ✓	✓			Digital	-	✓
6471 Kit 300 FT (no probes)	2135.60	0.001 Ω to 99.99 kΩ	Rechargeable Battery	✓		✓ / ✓	✓			Digital	Auto (41 to 513) Hz	✓
6471 Kit 500 FT (no probes)	2135.61	0.001 Ω to 99.99 kΩ	Rechargeable Battery	✓		✓ / ✓	✓			Digital	Auto (41 to 513) Hz	✓
6472	2135.51	0.001 Ω to 99.99 kΩ	Rechargeable Battery	✓		✓ / ✓	✓		✓***	Digital	Auto (41 to 5078) Hz	✓
6472 Kit 300 FT	2135.53	0.001 Ω to 99.99 kΩ	Rechargeable Battery	✓		✓ / ✓	✓		✓***	Digital	Auto (41 to 5078) Hz	✓
6472 Kit 500 FT	2135.54	0.001 Ω to 99.99 kΩ	Rechargeable Battery	✓		✓ / ✓	✓		✓***	Digital	Auto (41 to 5078) Hz	✓
4620	2130.43	(0.0 to 1999) Ω	Battery	✓		✓ / -	✓		-	Digital	-	-
4620 Kit 150 FT	2135.19	(0.0 to 1999) Ω	Battery	✓		✓ / -	✓*		-	Digital	-	-
4620 Kit 300 FT	2135.20	(0.0 to 1999) Ω	Battery	✓		✓ / -	✓		-	Digital	-	-
4620 Kit 500 FT	2135.21	(0.0 to 1999) Ω	Battery	✓		✓ / -	✓		-	Digital	-	-
4630	2130.44	(0.0 to 1999) Ω	Rechargeable Battery	✓		✓ / -	✓		-	Digital	-	-
4630 Kit 150 FT	2135.22	(0.0 to 1999) Ω	Rechargeable Battery	✓		✓ / -	✓*		-	Digital	-	-
4630 Kit 300 FT	2135.23	(0.0 to 1999) Ω	Rechargeable Battery	✓		✓ / -	✓		-	Digital	-	-
4630 Kit 500 FT	2135.24	(0.0 to 1999) Ω	Rechargeable Battery	✓		✓ / -	✓		-	Digital	-	-

\* Performing soil resistivity tests with this kit requires two additional auxiliary electrodes not supplied in the 150 ft kit and one additional test lead.

\*\* Clamp-on Ground Resistance Tester can measure system continuity inclusive of all bonding points.

\*\*\* Must purchase an additional (2) SR182 or (2) MN82 accessory clamps.

## CLAMP-ON

AEMC MODEL NUMBER	AEMC CATALOG NUMBER	RESISTANCE RANGE	POWER SOURCE	VOLTAGE INDICATION	INDUCTANCE MEASUREMENT- mH	SELETABLE FREQUENCY	ALARM	MEMORY	BLUETOOTH
6416	2141.01	(0.01 to 1500) Ω	Battery	Voltage Displayed (noise icon, buzzer)	✓		3 separate alarms (Ω, V and A)	300 measurements	-
6417	2141.02	(0.01 to 1500) Ω	Battery	Voltage Displayed (noise icon, buzzer)	✓		3 separate alarms (Ω, V and A)	2000 measurements	Yes
6418	2141.03	(0.01 to 1200) Ω	Battery	Noise Icon	-	✓	2 separate alarms (Ω and A)	300 measurements	-